

Installation Instructions Part Number

84491759

Kit Contents

Qty	Description
1	Rear Closure Center Applique
1	Installation Instructions

Procedure

Removal

1. Open liftgate.

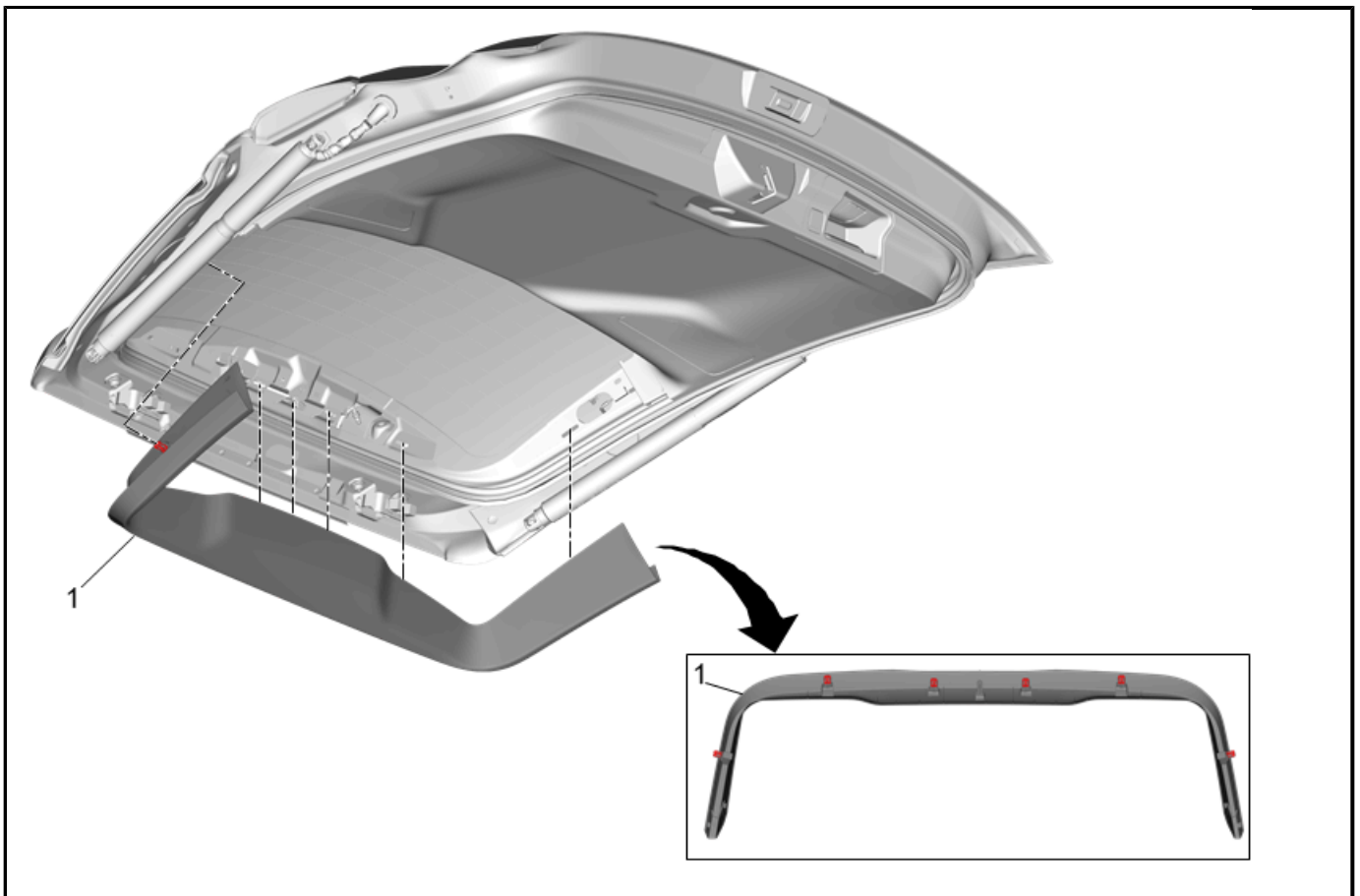

4375461

2. Using the appropriate trim tool, release the liftgate upper trim finish panel (1) from the liftgate inner panel.

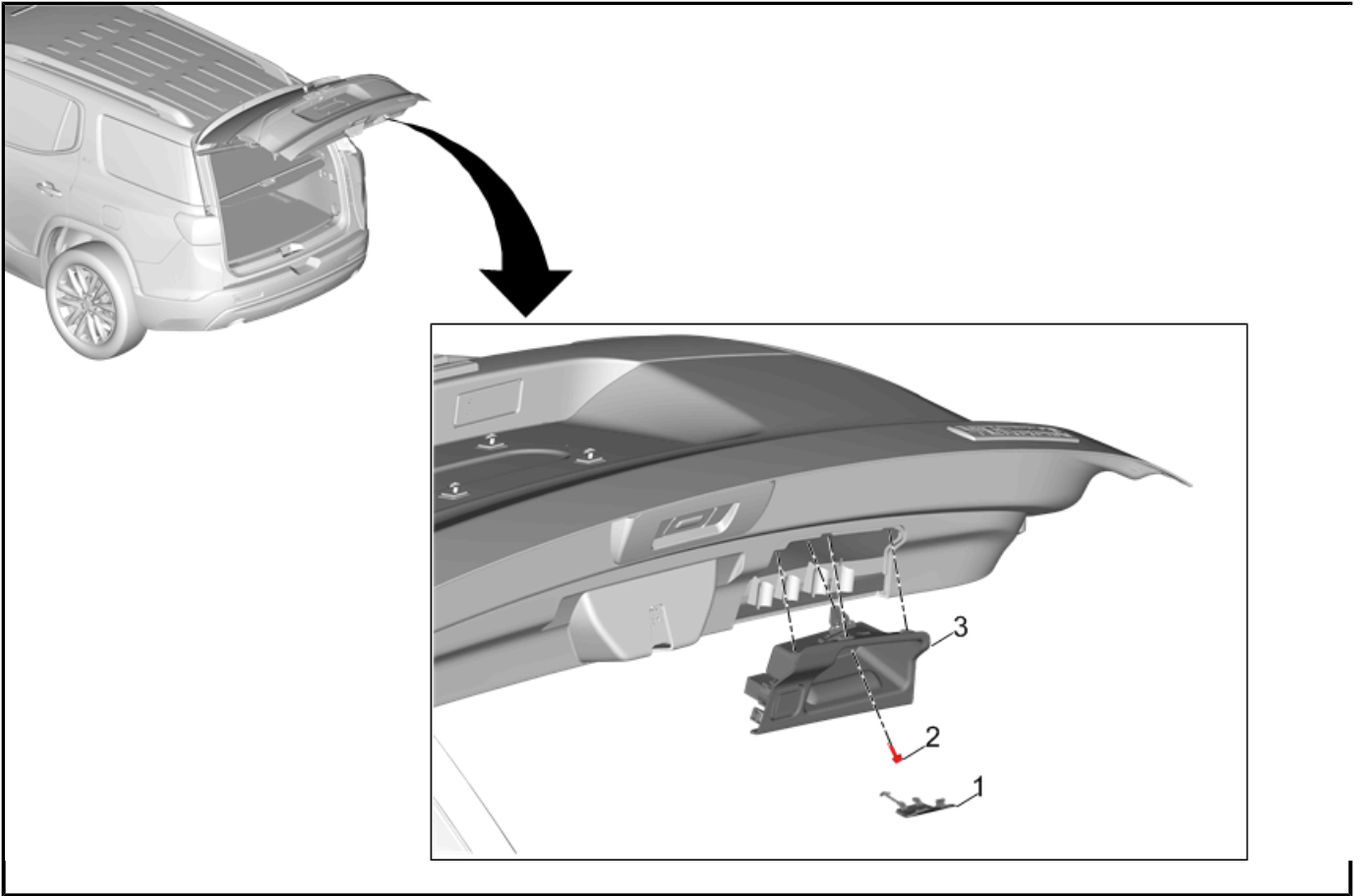

4373494

3. Remove the liftgate pull cup cap (1).
4. Remove and retain the liftgate lower trim finish panel bolt (2).
5. Using a flat bladed plastic trim tool, remove the liftgate trim finish panel pull cup (3).
6. Disconnect the electrical connector.

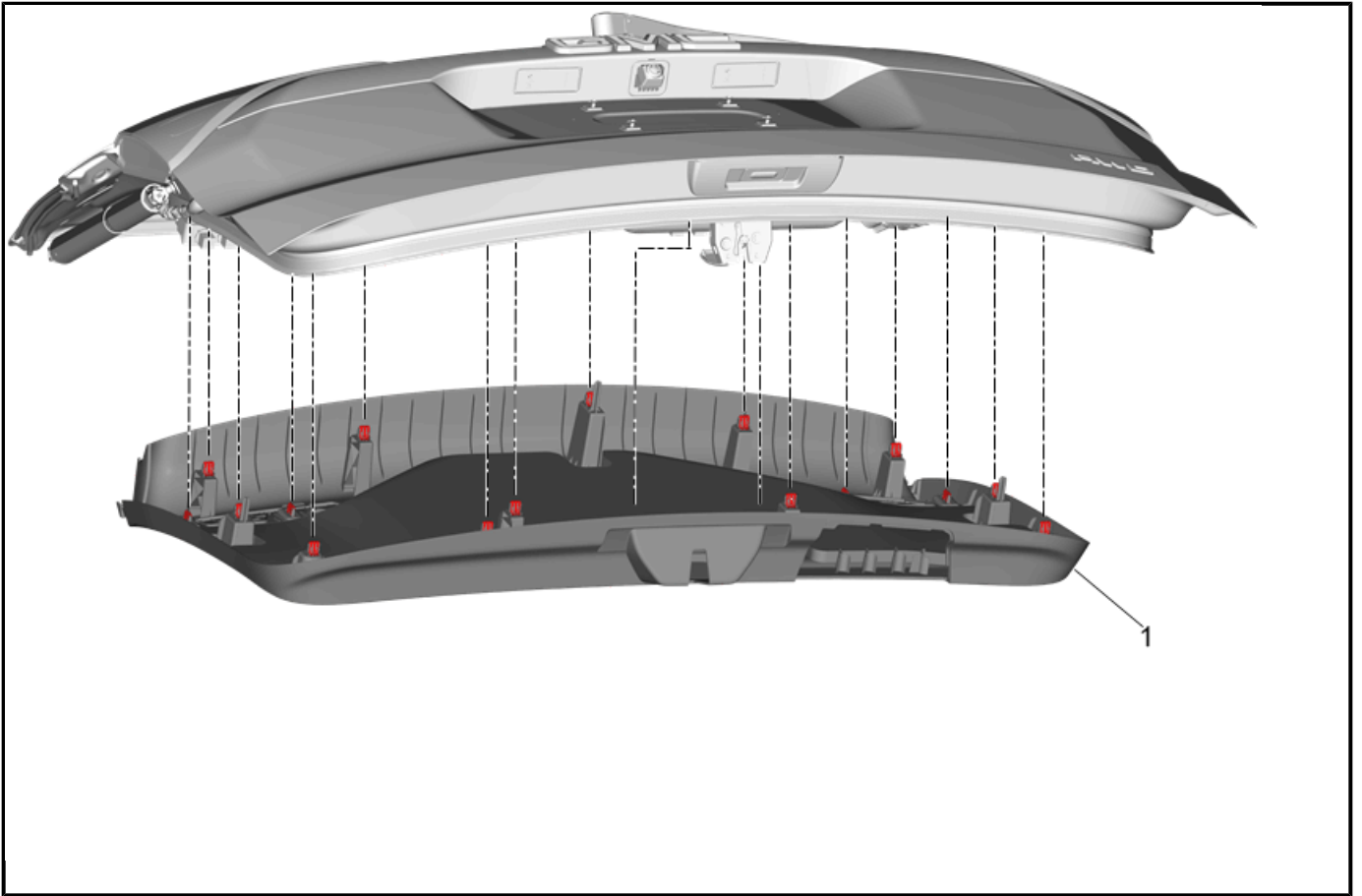

4375596

7. Using a trim panel removal tool, remove the liftgate lower trim finish panel (1) from the liftgate assembly.
8. Disconnect the electrical connector, if equipped.

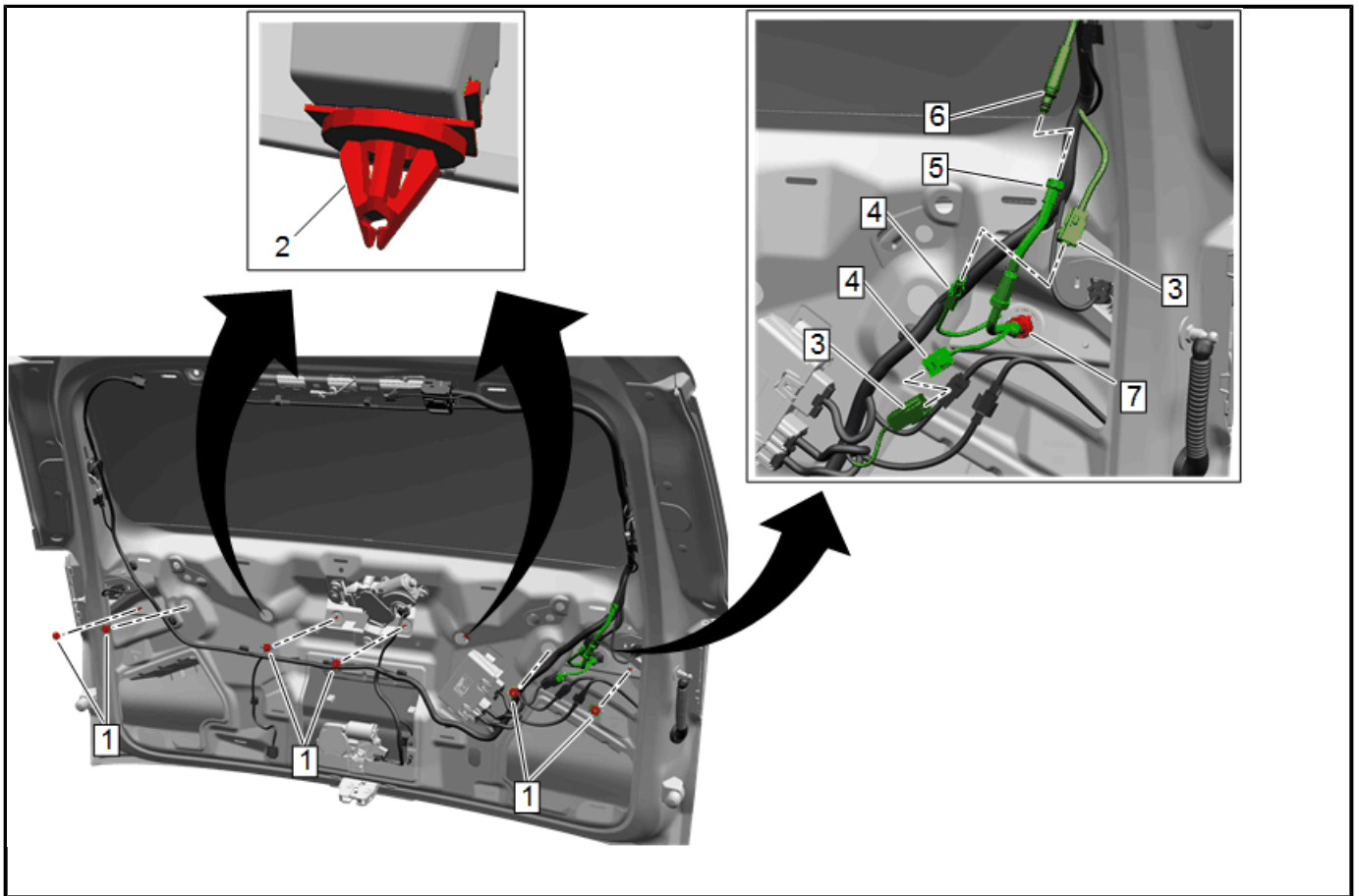

5066785

9. Remove the license plate applique nuts (1) Qty: 6.
10. Using a trim type release tool, disengage the retainers (2) on the license plate applique.
11. Disconnect rear closure center applique electrical connectors (4) from liftgate harness (3).
12. Disconnect the rear closure center applique washer hose (5) from liftgate washer hose (6) and disengage grommet (7).

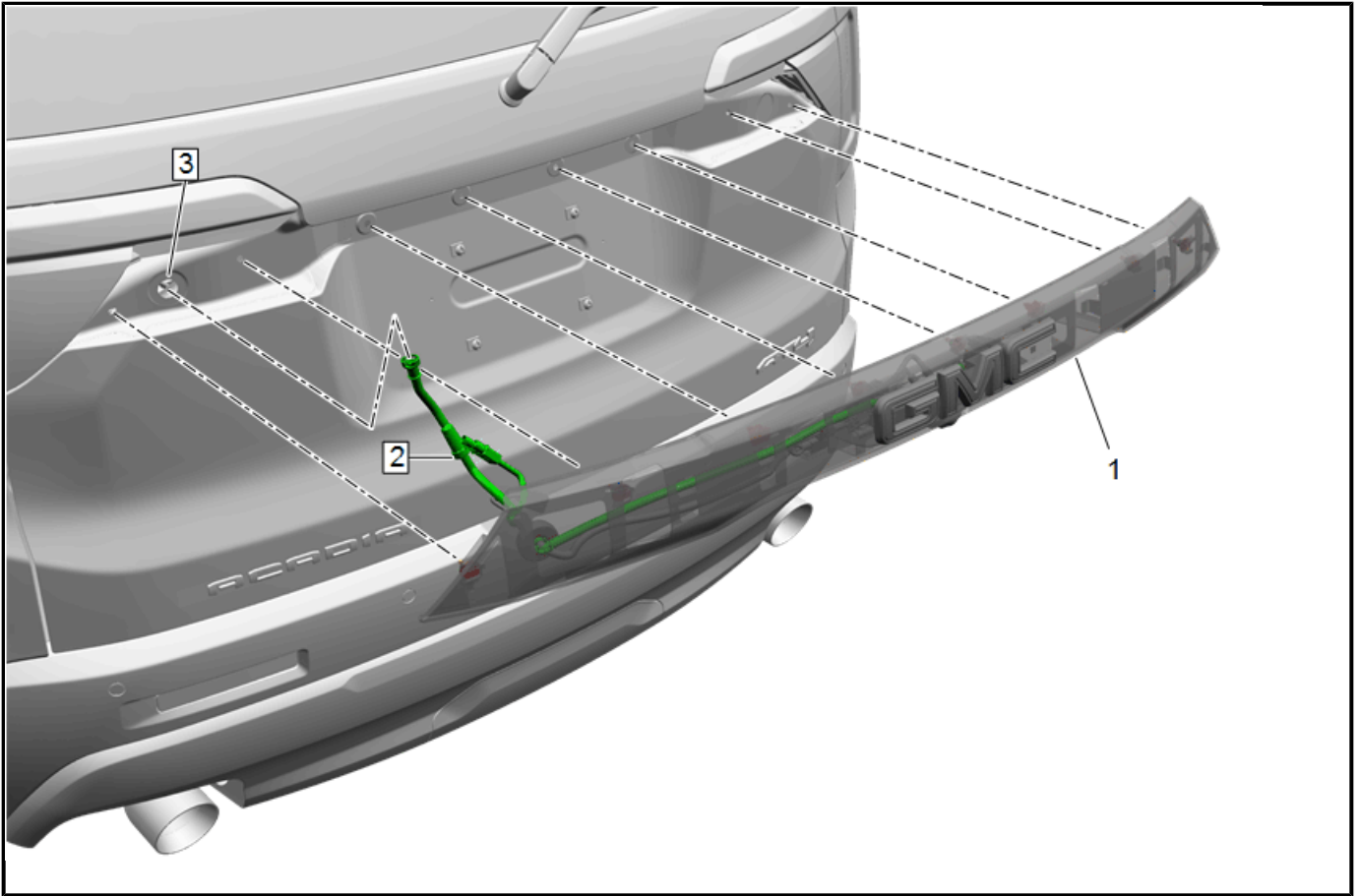

5066835

13. Remove the rear closure center applique (1) from liftgate and pull washer hose/harness (2) from hole (3).

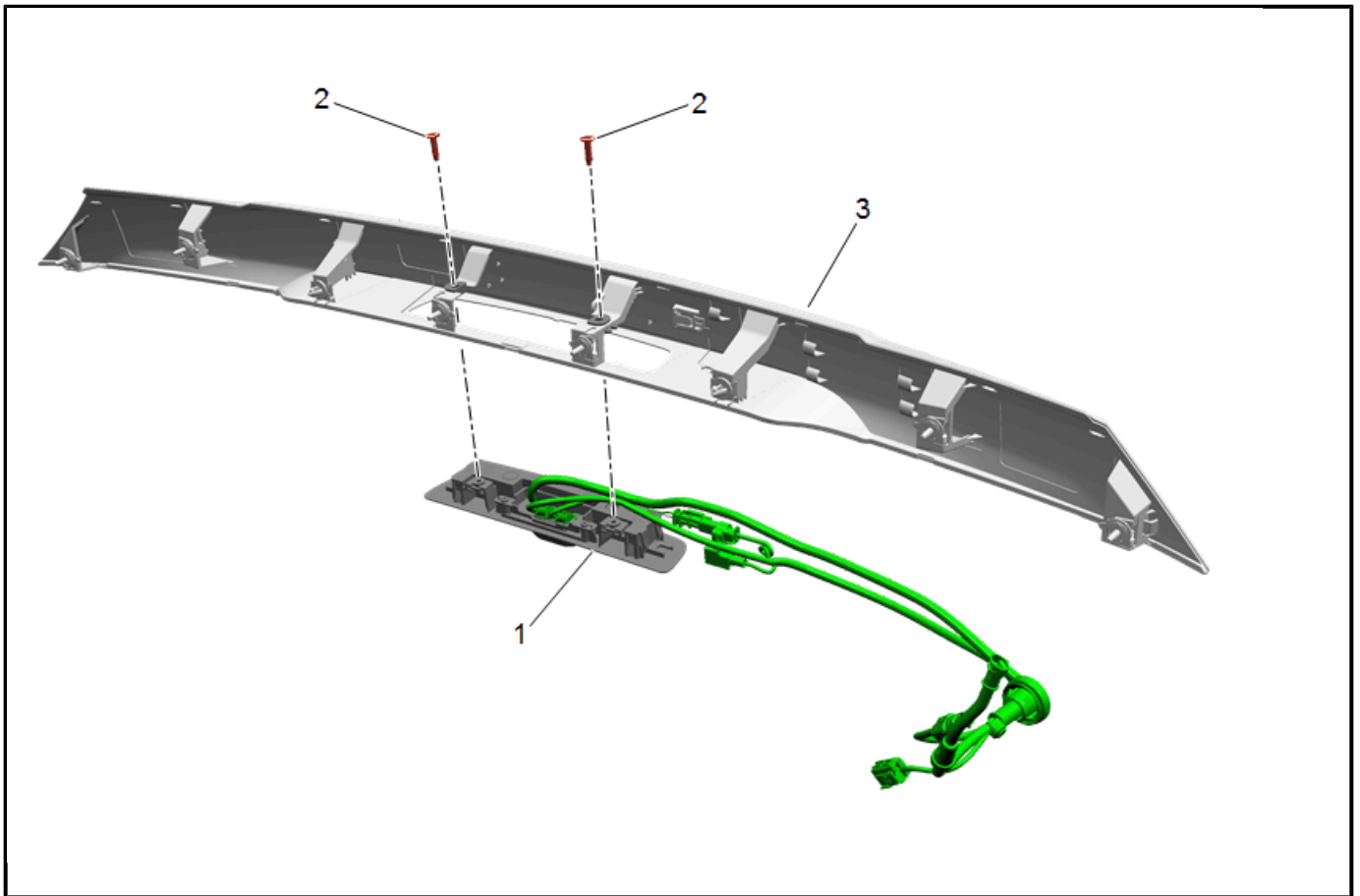

5066839

14. Remove and retain the screws (2) securing the license lamp/camera assembly (1) to the rear closure center applique (3).
15. Remove the license lamp/camera assembly (1) from the rear closure center applique (3).
16. Disengage the washer hose/harness from the rear closure center applique (3).

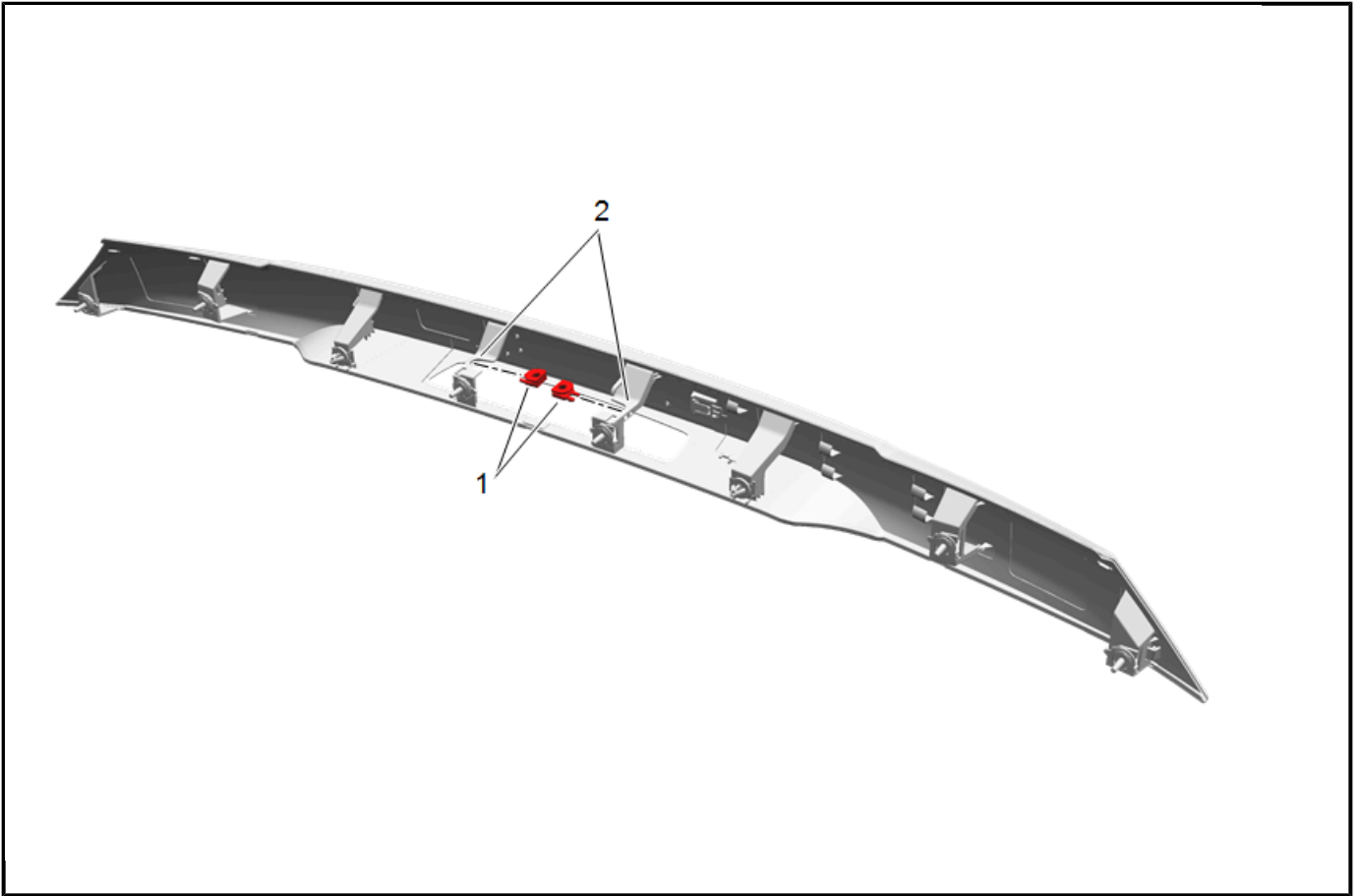

5066842

17. Remove and retain the spacers (1) from the rear closure center applique (2).

Installation

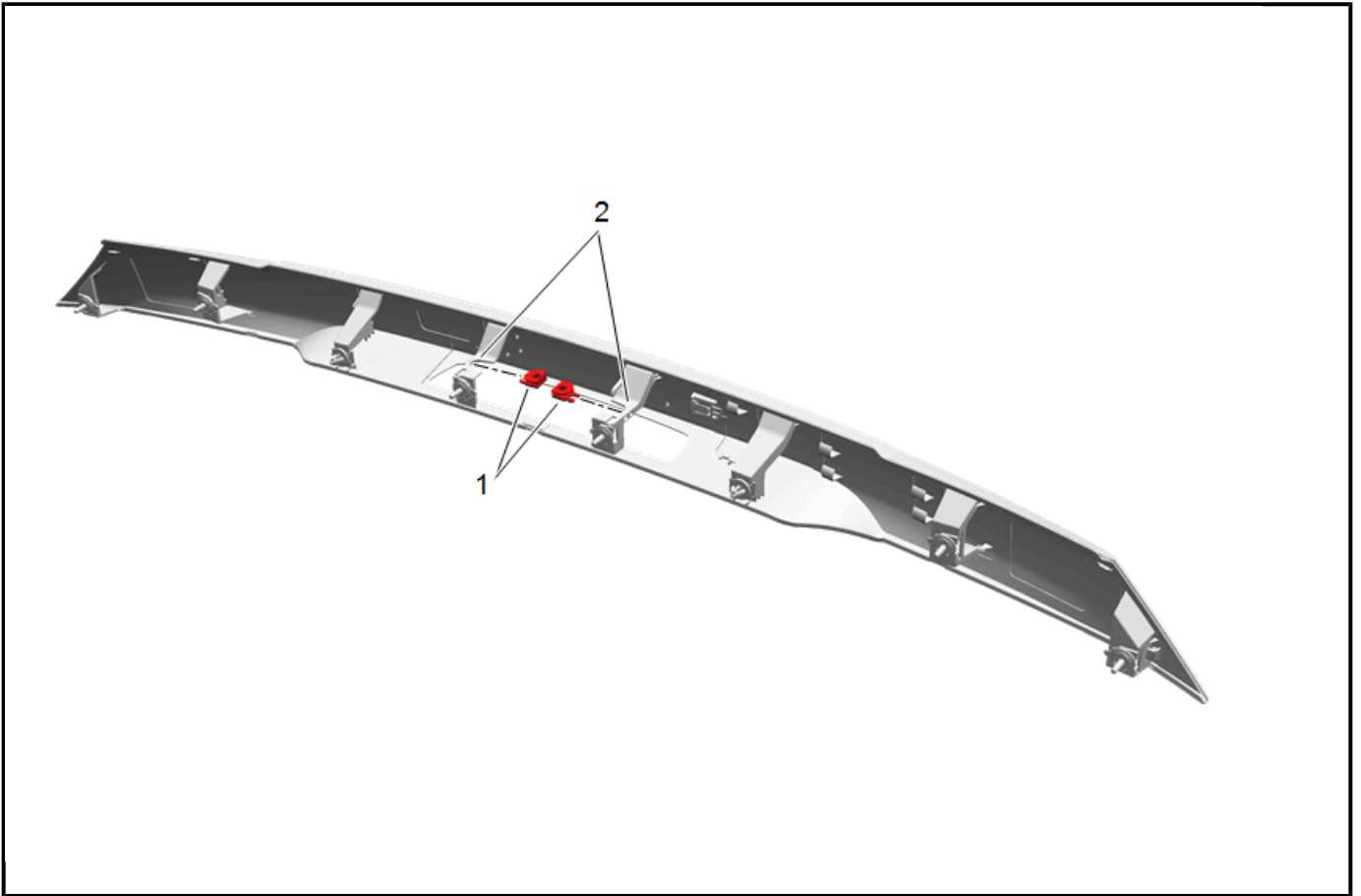

5066842

1. Install the previously retained spacers (1) to the new rear closure center applique (2).

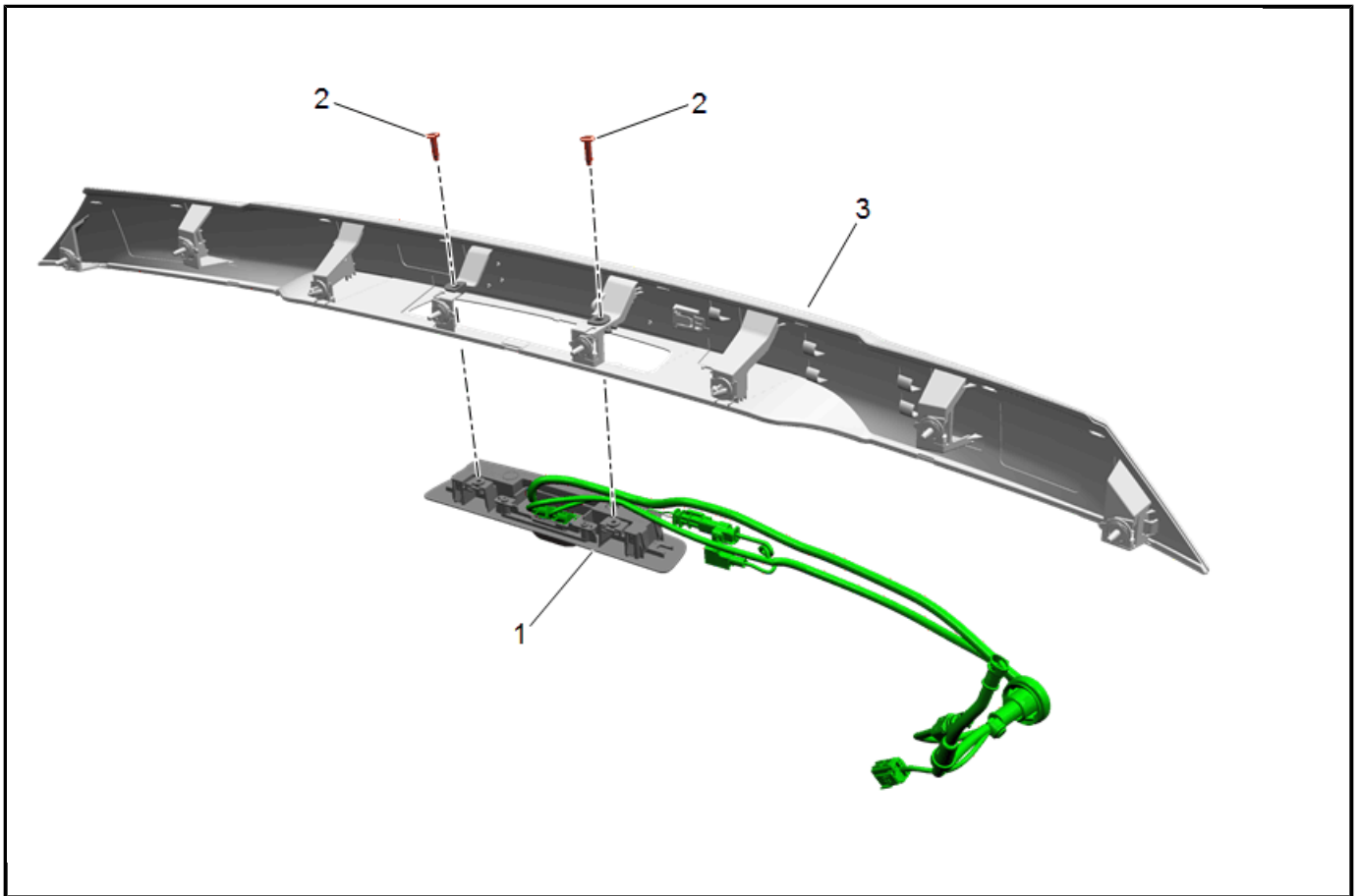

5066839

2. Position the license lamp/camera assembly (1) to the new rear closure center applique (3) while routing and engaging the washer hose/harness to the rear closure center applique (3).

Caution: Use the correct fastener in the correct location. Replacement fasteners must be the correct part number for that application. Fasteners requiring replacement or fasteners requiring the use of thread locking compound or sealant are identified in the service procedure. Do not use paints, lubricants, or corrosion inhibitors on fasteners or fastener joint surfaces unless specified. These coatings affect fastener torque and joint clamping force and may damage the fastener. Use the correct tightening sequence and specifications when installing fasteners in order to avoid damage to parts and systems.

3. Install the previously retained screws (2) to the license lamp/camera assembly (1). Tighten the screws to 4.7 N.m (42 lb in).

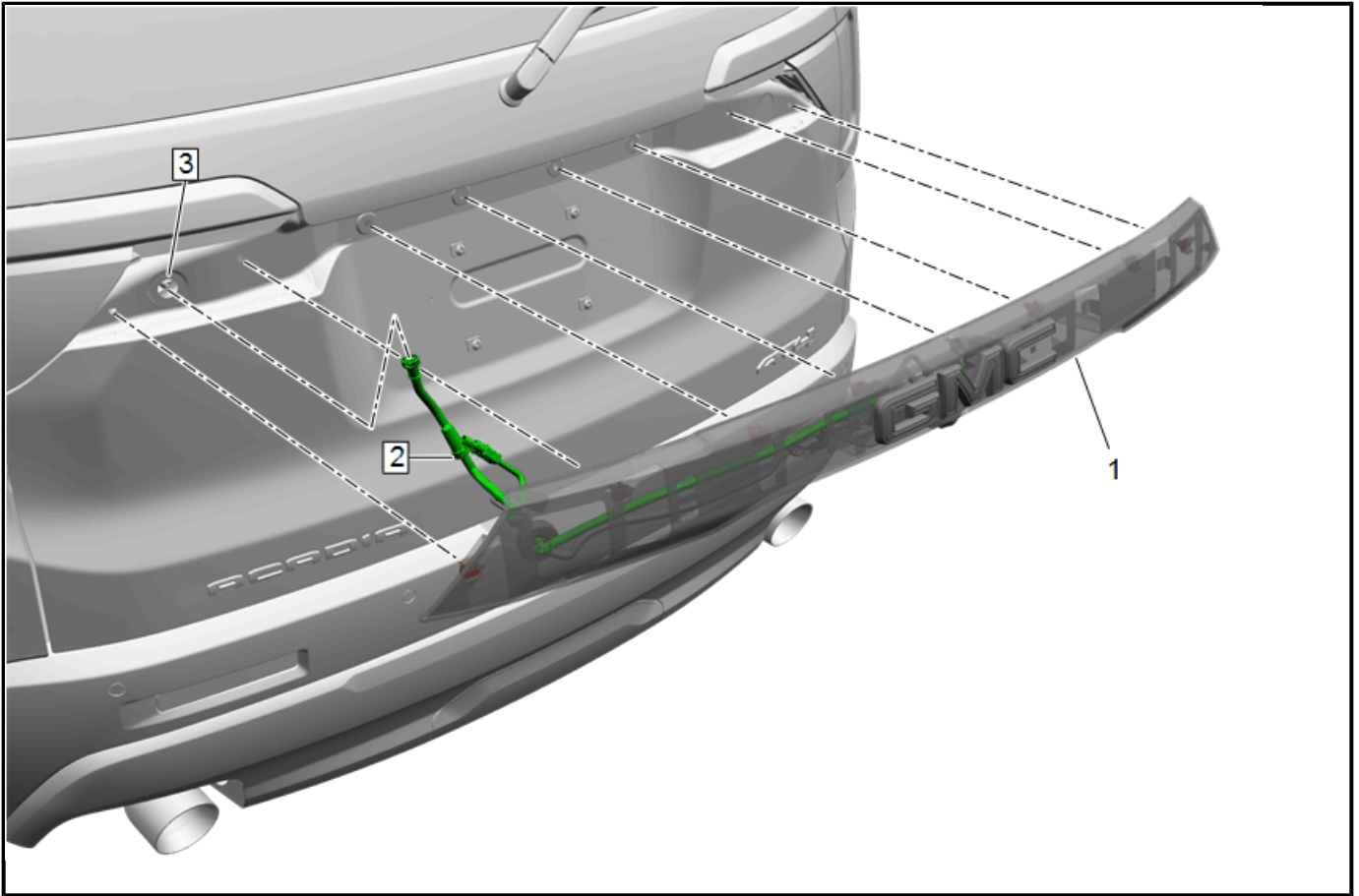

5066835

4. Position the new rear closure center applique (1) to the liftgate while routing the washer hose/harness (2) through the hole (3).

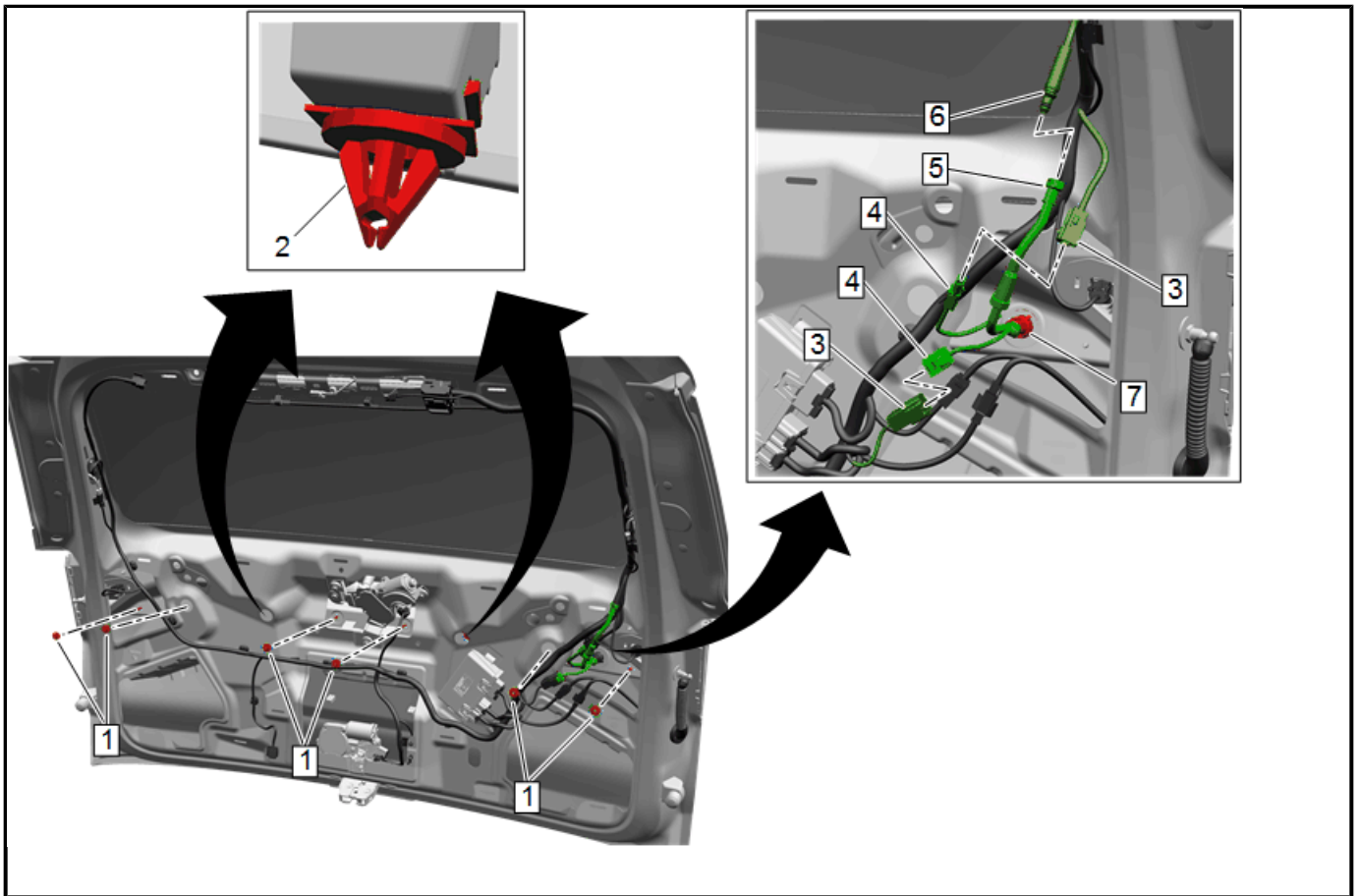

5066785

5. Engage the retainers (2) Qty: 2 on the rear closure center applique.
6. Install the previously retained rear closure center applique nuts (1) Qty: 6. Tighten the nuts to 4.7 N.m (42 lb in).
7. Connect the rear closure center applique washer hose (5) to liftgate washer hose (6) and engage grommet (7).
8. Connect rear closure center applique electrical connectors (4) to liftgate harness (3).

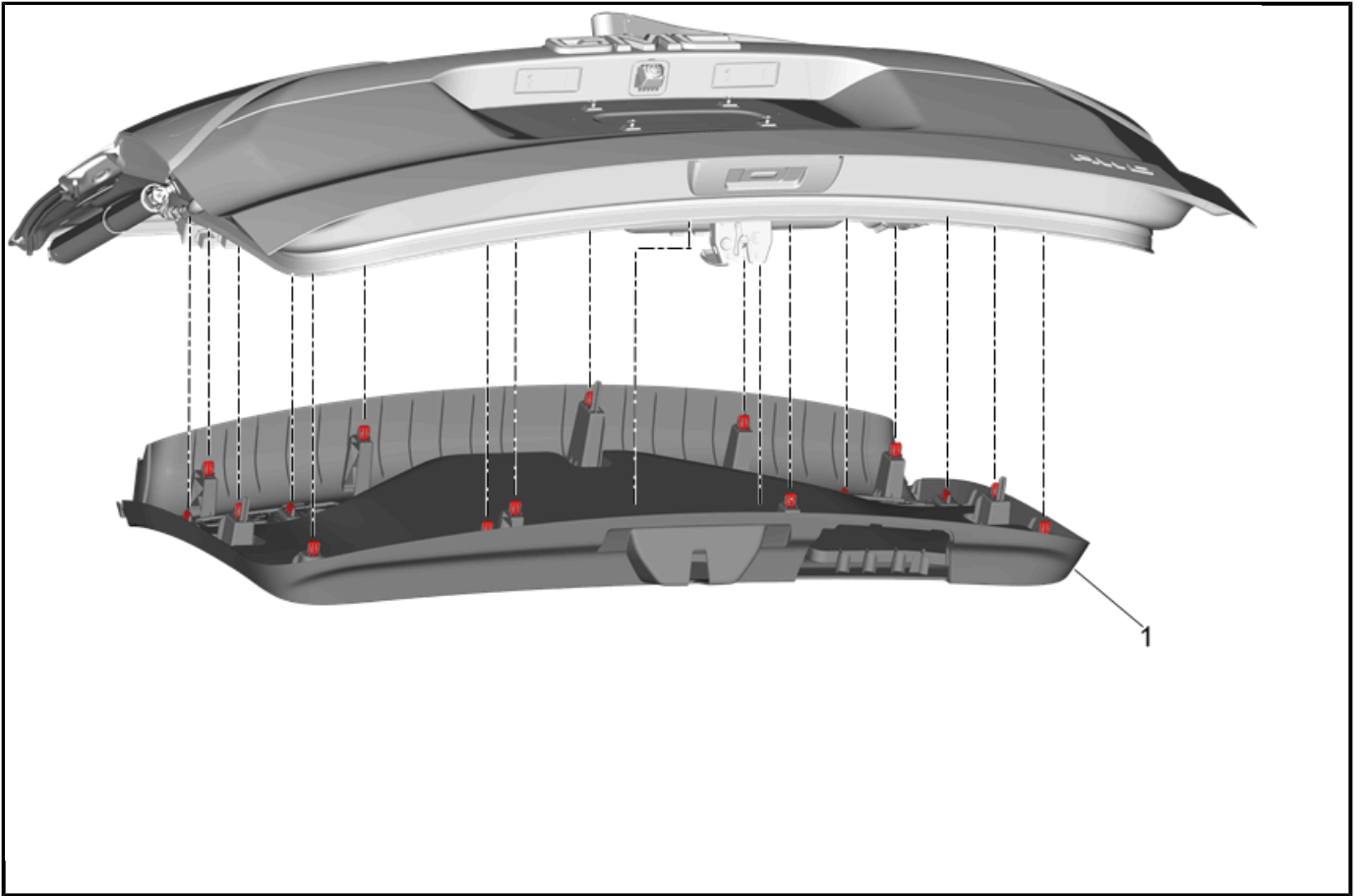

4375596

9. Connect the electrical connector, if equipped and install the liftgate lower trim finish panel (1) to the liftgate assembly.

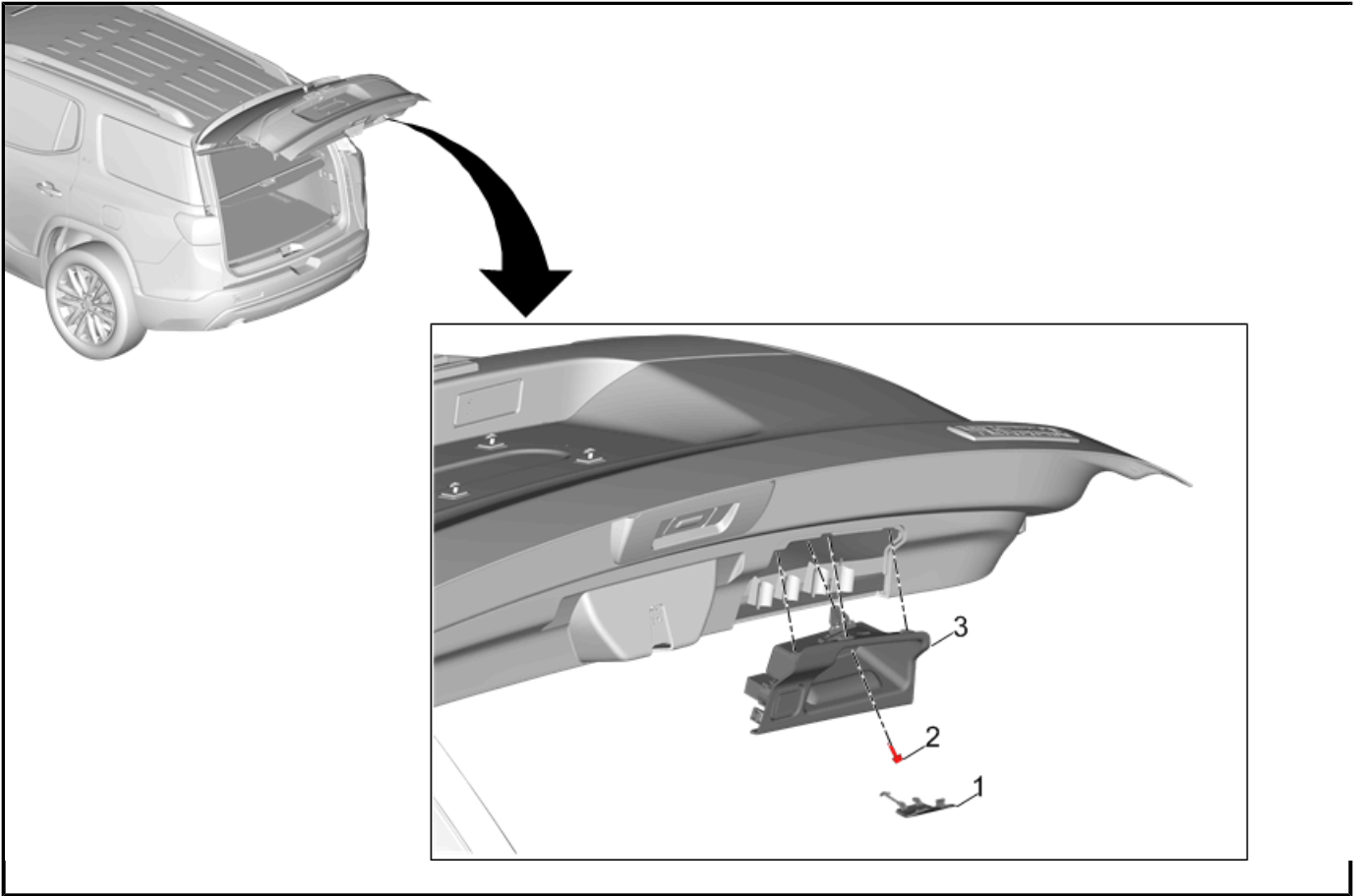

4373494

10. Connect the electrical connector and install the liftgate trim finish panel pull cup (3).
11. Install the previously retained liftgate lower trim finish panel bolt (2). Tighten the bolt to 2.5 N.m (22 lb in).
12. Install the liftgate pull cup cap (1).

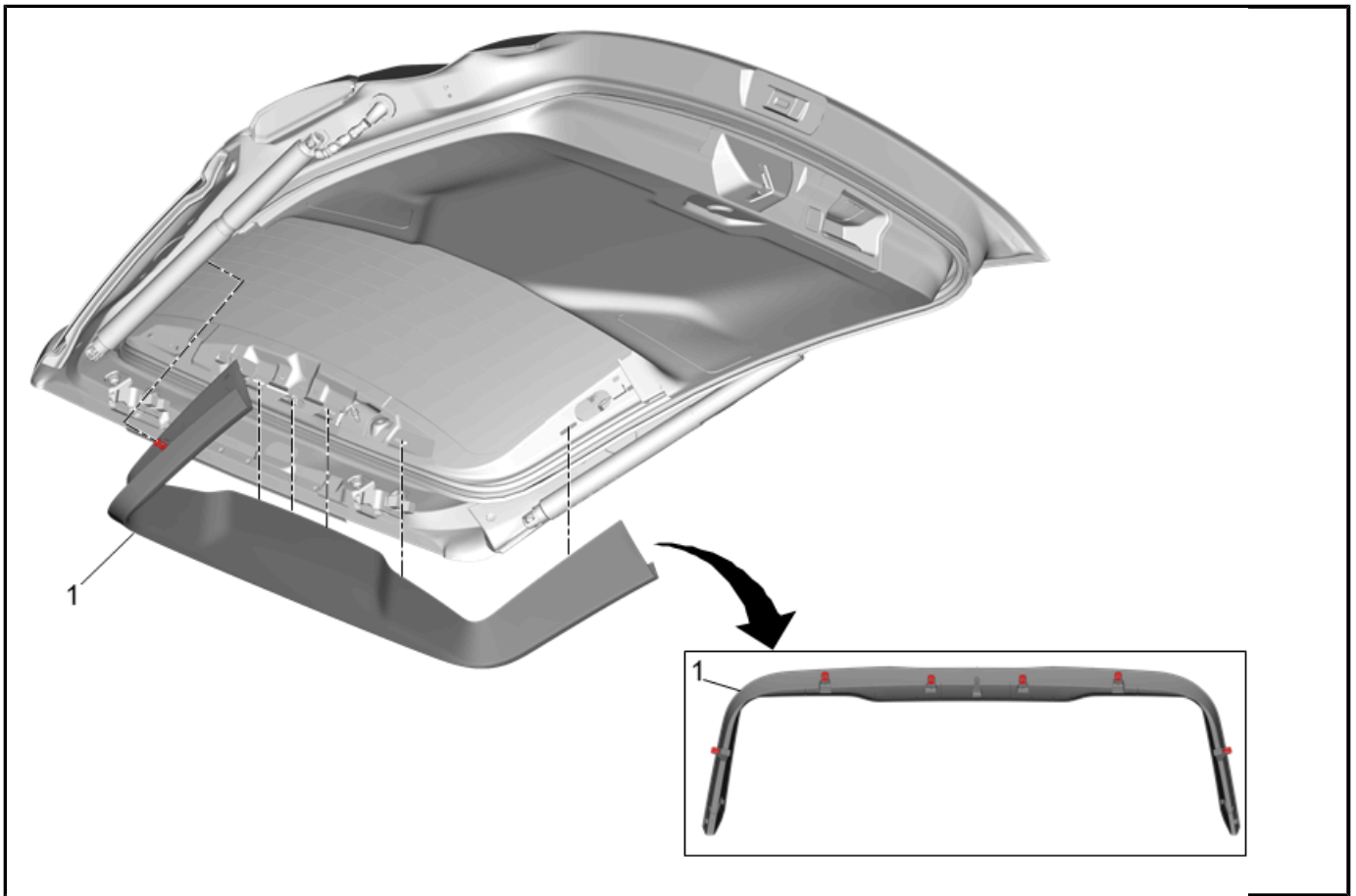

4375461

13. Install the liftgate upper trim finish panel (1) to the liftgate inner panel.
14. Close the liftgate.