

# Front Side Door Sill Front Trim Plate Package Installation

## Installation Instructions Part Number

85163965

**Note:** Please review the entire procedure before trying to perform it.

### Kit Contents

Qty	Description
2	Illuminated Sill Plate Assembly
1	Wiring Harness Pkg (Contains Harness ASM (qty 1), Abrasive Tapes (qty 8), foam tapes (qty 2) and Wire Tie Straps (qty 8))
1	Instruction Sheet

### Recommended Tools

- Flat Bladed Plastic Trim Tool
- GM Terminal Remover Tool P/N 12152110, 15315247, or 12094429 (7J04899)
- Push-in Retainer Puller
- Electrical Tape
- 10mm Socket
- Trim Removal Tools
- Small Ratchet
- Wire Puller
- Heat Gun
- Wire Crimp Tool
- Magnet and / or Vacuum
- Weather Strip Roller Tool
- Isopropyl Alcohol
- Clean Cloth/Rag

### Procedure

1. Move the front seats to the furthest rearward position.

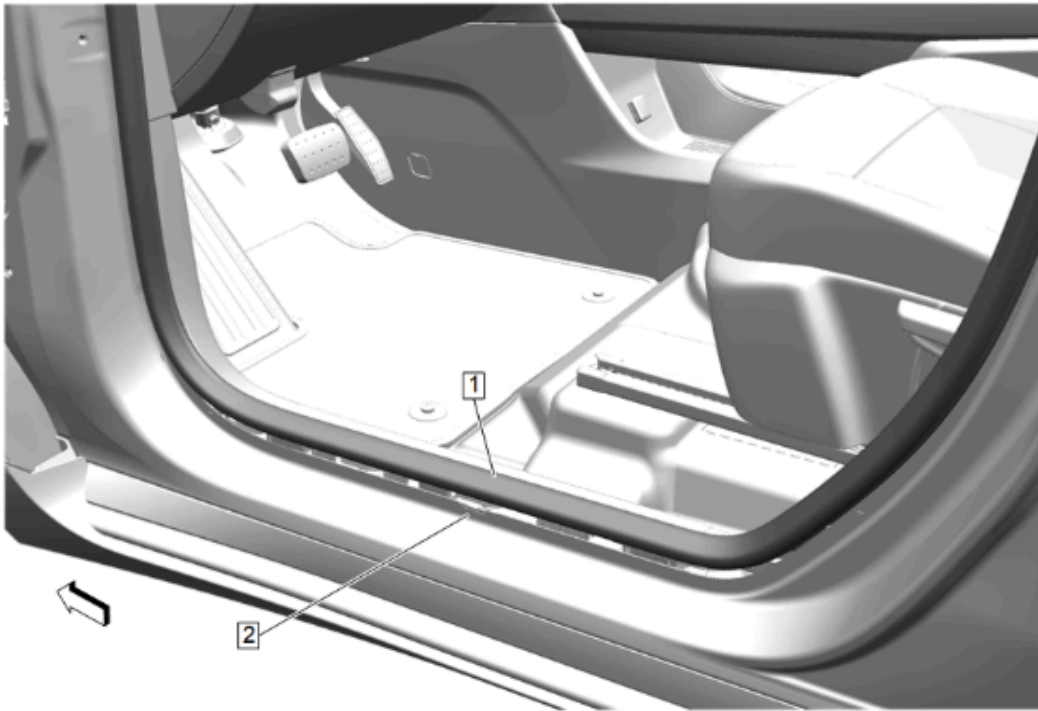

2. Lift up on door sill weather strip (1) until notch (2) on rocker panel is exposed.
  3. Remove the left and right front side door sill garnish moldings. Refer to [Front Side Door Sill Garnish Molding Replacement](#) in Vehicle Service Manual.
  4. Remove the left and right non-lit front door sill plates. Refer to [Front Side Door Sill Trim Plate Replacement](#) in Vehicle Service Manual.
- Note:** Clean around the area of the lower door frame on both sides with isopropyl alcohol.
5. Remove the left and right front floor console side trim panels. Refer to [Front Floor Console Extension Panel Replacement](#) in Vehicle Service Manual.
  6. Remove the front floor mats.

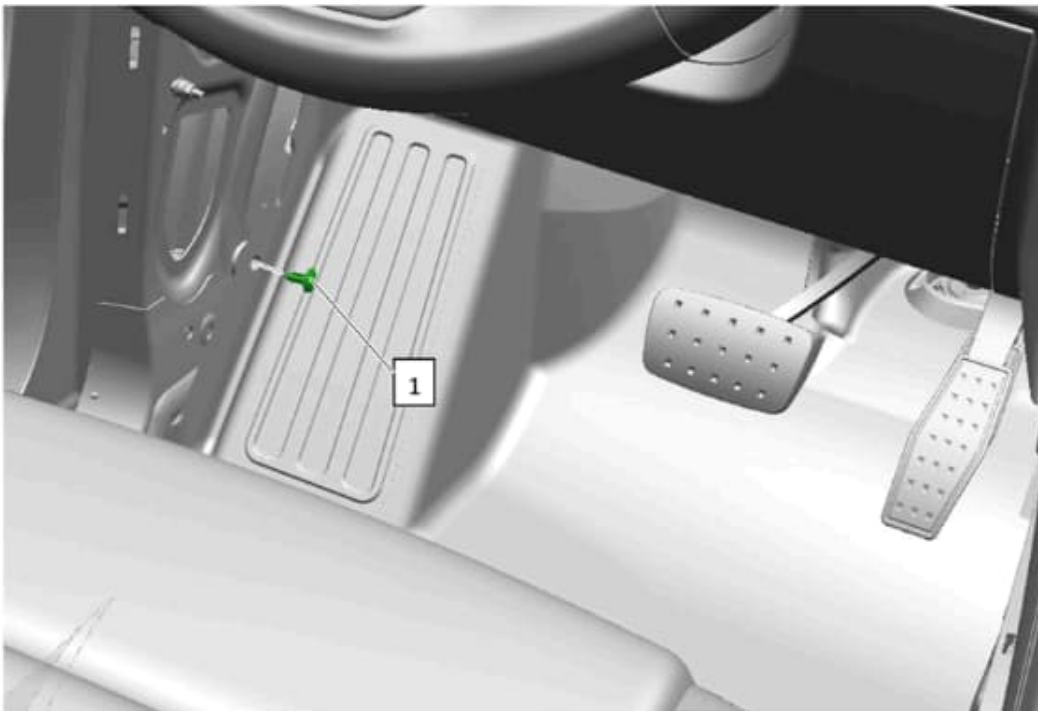

7. Remove the driver side carpet retainer (1) and reposition the carpet.

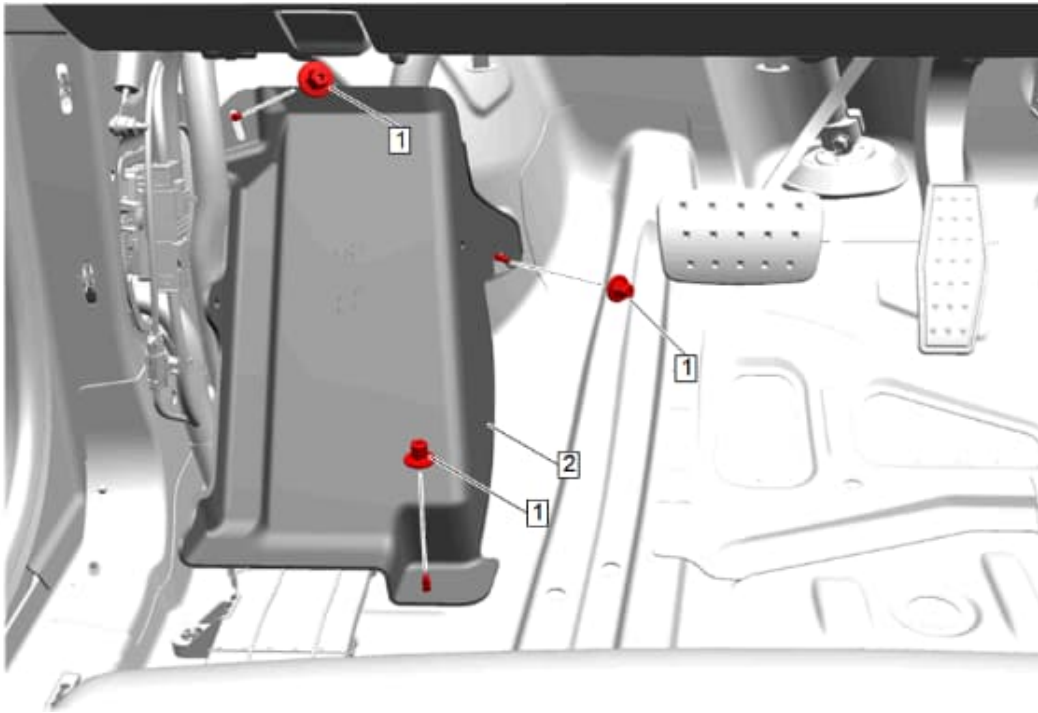

8. Remove the foot rest retainers (1) and remove foot rest (2) from driver side.

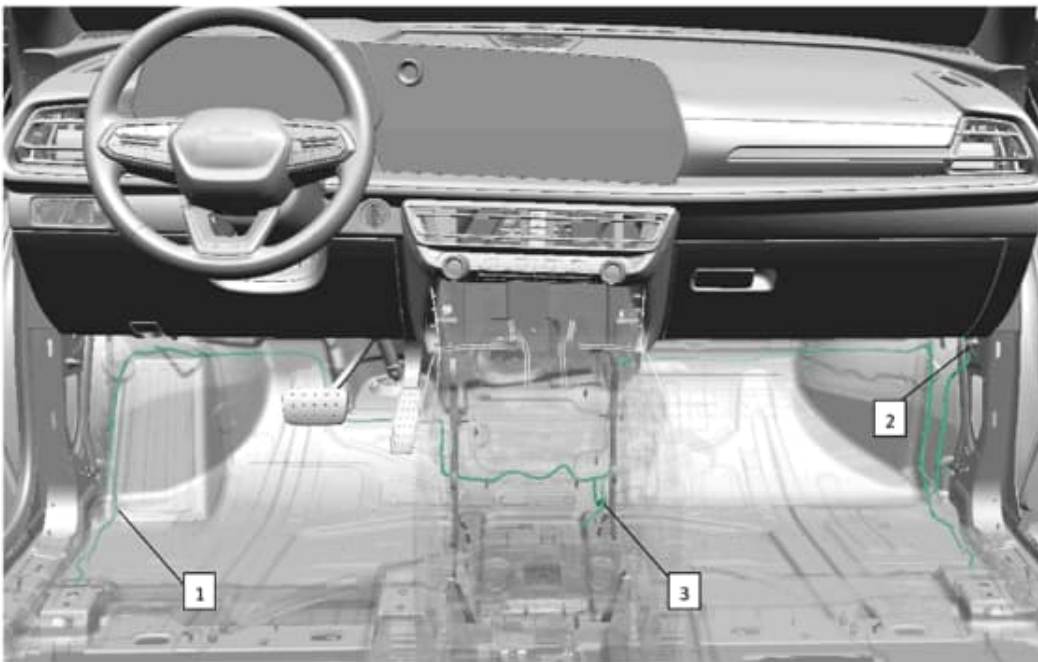

9. Route wiring harness through the vehicle as shown.

9.1. Begin by spreading out the harness to understand how it is routed through the vehicle. The harness will route from the driver side, to the passenger side, near the top edge of the carpet. The ground eyelet (2) attaches in the passenger side cowl and the two loose wires (3) attach to the BCM under the floor console on the passenger side.

9.2. Route the harness (1) loosely across the bottom of floor console with the BCM connections on passenger side under floor console, and ground (2) on the right side.

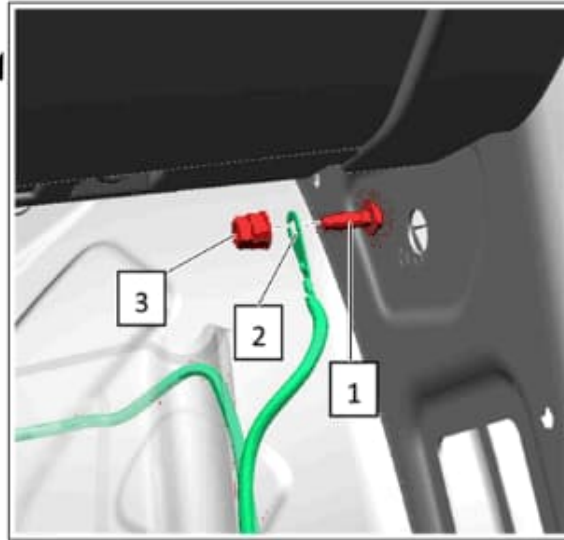

10. Locate an unused ground on the passenger side cowl. If no unused ground is available, use a ground that has only one eyelet (1) present.
11. Remove the ground bolt nut (3) and install the illuminated sill plate harness ground eyelet (2).

**Caution:** Use the correct fastener in the correct location. Replacement fasteners must be the correct part number for that application. Fasteners requiring replacement or fasteners requiring the use of thread locking compound or sealant are identified in the service procedure. Do not use paints, lubricants, or corrosion inhibitors on fasteners or fastener joint surfaces unless specified. These coatings affect fastener torque and joint clamping force and may damage the fastener. Use the correct tightening sequence and specifications when installing fasteners in order to avoid damage to parts and systems.

12. Reinstall the ground bolt nut and tighten to 25 N.m using a 10mm socket.

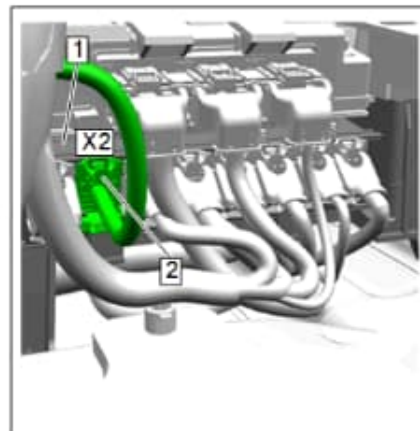
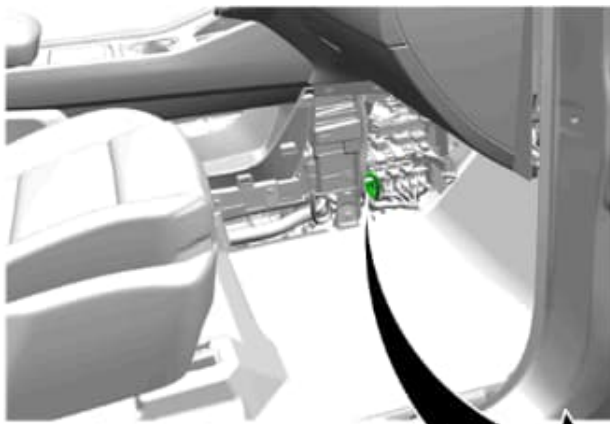

13. Locate the BCM (1) on the passenger side of the vehicle, under the floor console. Disconnect BCM connector (2) X2.

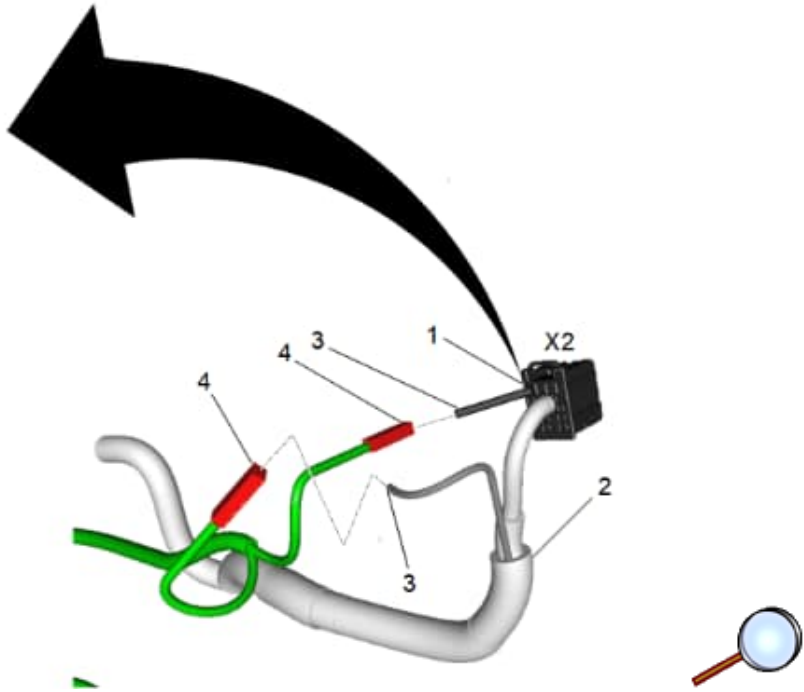
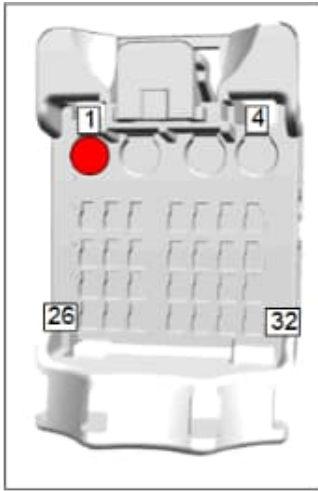

14. Locate cavity #1 on the on the removed connector (1). Remove wire harness covering (2) starting from connector for approximately 4".
15. Gently separate the wire (3) leading to cavity #1 from the rest of wire bundle.
16. Approximately 50 mm from the rear of the connector cut the wire (3) leading to cavity #1.
17. On the supplied wire harness locate 2 blunt (unterminated) ends routed near BCM. Using recommended service technique and the supplied crimp splices (4) splice 1 blunt end to each side of the cut wire.
18. Seal splices and re-tape harness to within 25 mm of rear of connector.
19. Plug in the wire harness connector to the illuminated sill plate wire harness. Do not fully seat the illuminated sill plates at this time.

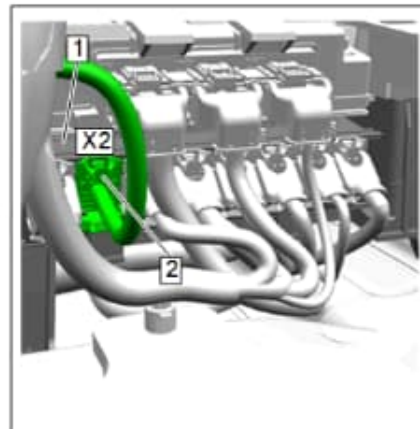
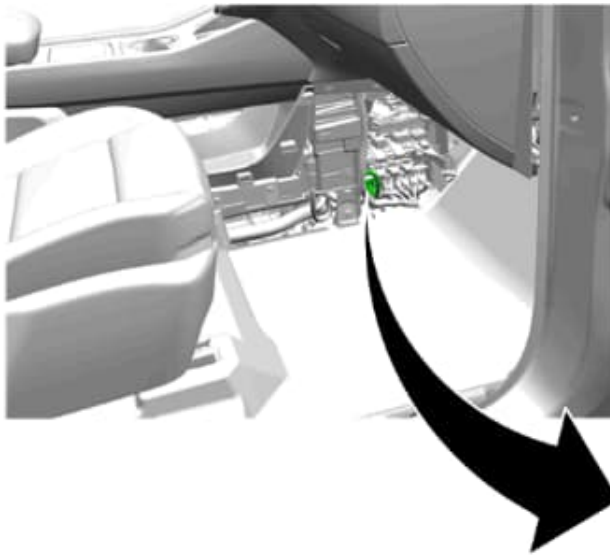

20. Re-connect connector X2 (2) to the BCM (1).

## Check Operation of the Illuminated Sill Plates

### Verify Illuminate Sill Plate Operation

- Verify all disconnected electrical connections are re-connected.
- Close all doors
- Open each door, door sill will illuminate when the dome light illuminates.
- The door sill plates should light up and go out with dome lamp (make sure dome lamp is on).
- If the sill plates do not light up, check the ground and BCM splice as well as other connections at illuminated door sills, (make sure dome lamp switch is not in defeat position).
- Check to see if the courtesy lights are working.
- Verify that the sill plates are operating correctly.

### Fully Install Illuminated Sill Plates

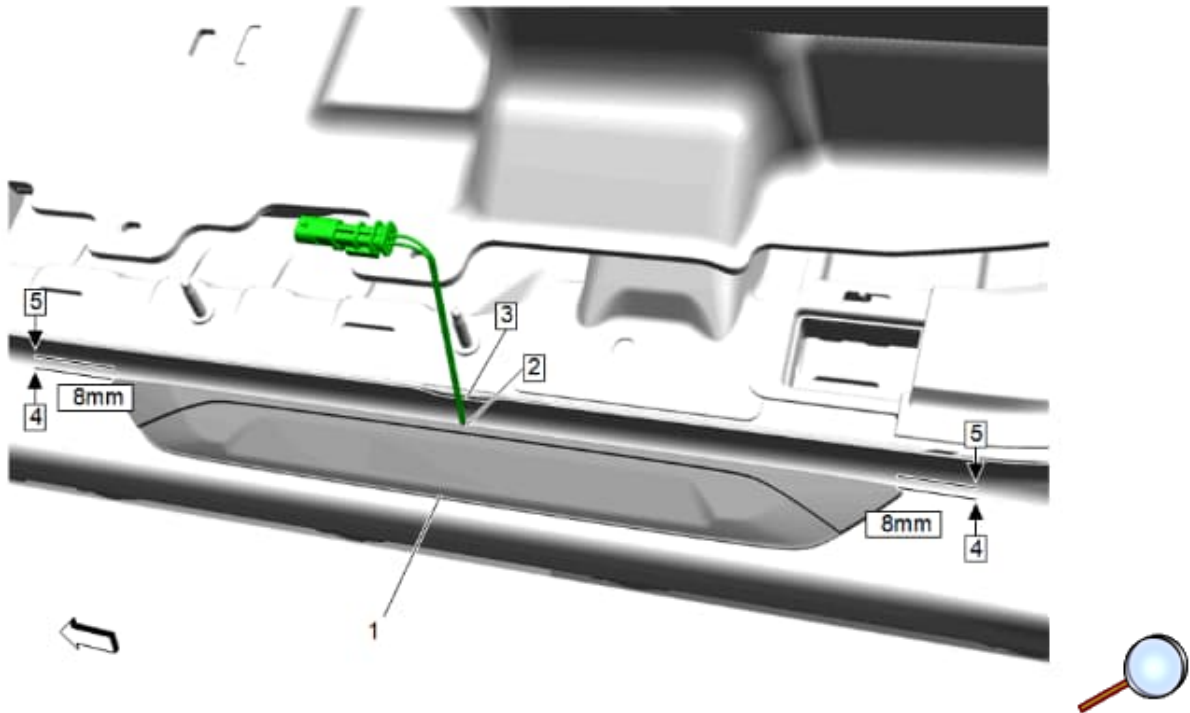

**Note:** The illuminated sill plates can be installed on either side of the vehicle.

1. Remove the adhesive tape liner from the back of illuminated sill plate (1). Align the harness at the center of sill plate (2) with the notch (3) on the rocker panel, while positioning the sill plate top edge (4) 8mm from the inner edge (5) of rocker panel. and firmly press into place until the sill plate is fully seated.

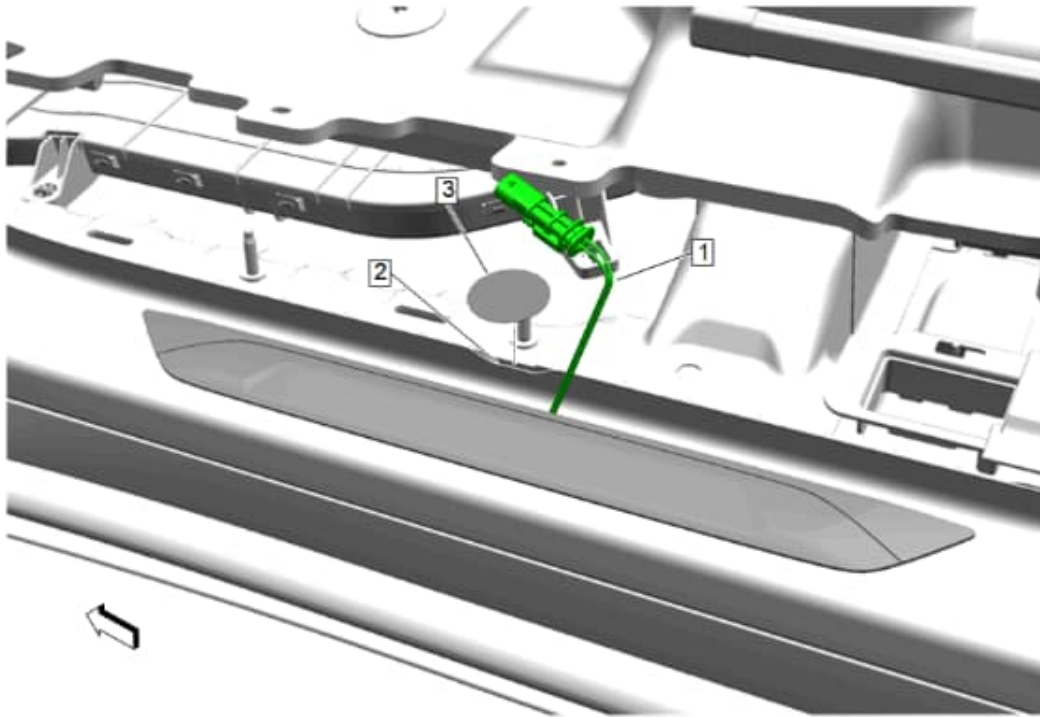

**Note:** Eight abrasive tapes are provided in the harness package.

2. Reposition harness (1) and place one abrasive tape (3) on the rocker panel notch (2).

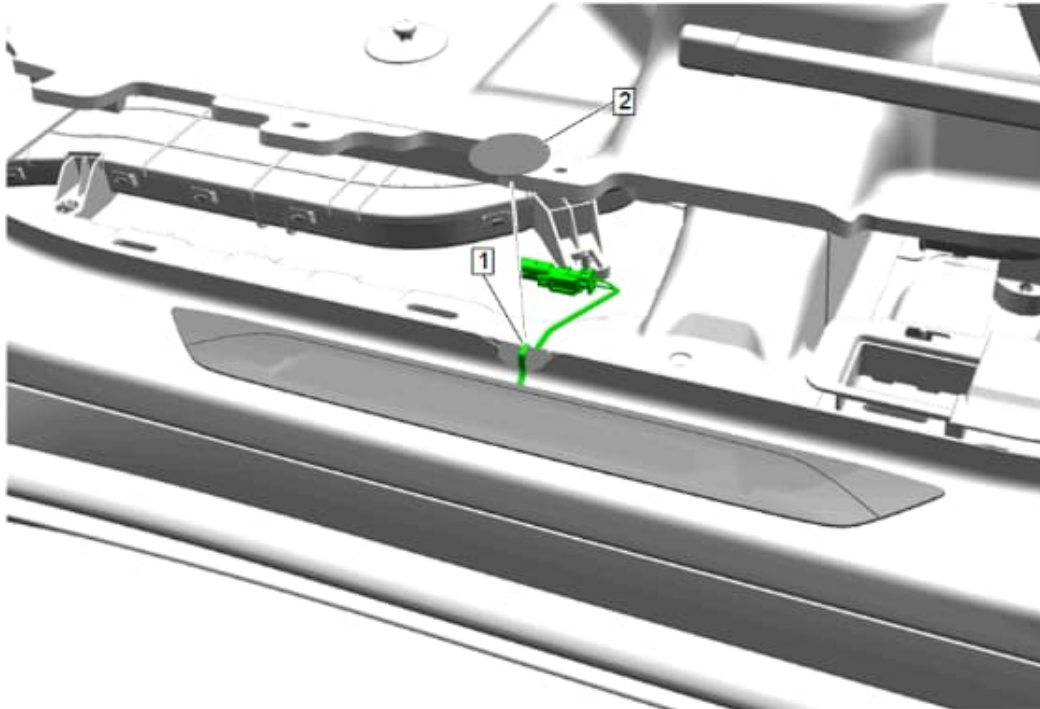

3. Route the pigtail wiring (1) across the notch on the rocker panel and cover wiring with abrasive tape (2) to keep pigtail wiring secure.

4. Repeat for the second illuminated sill plate on the opposite side of the vehicle.

**Complete the Wire Harness Routing**

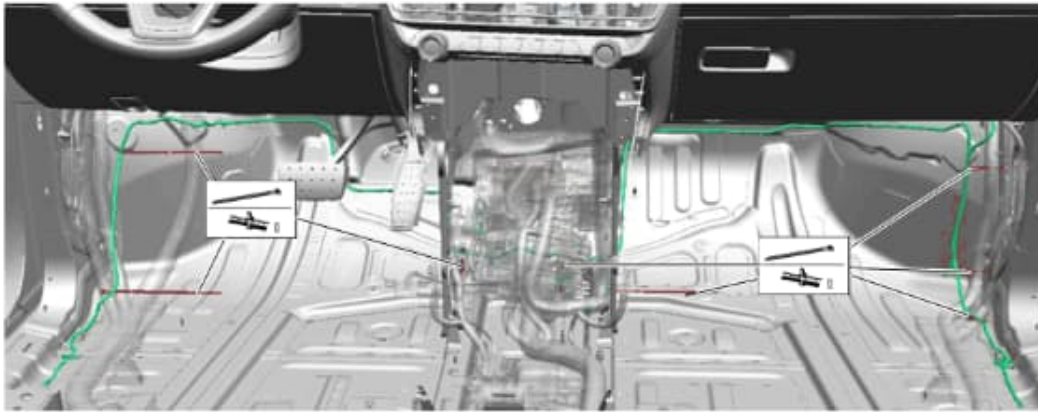

1. Use tie straps, as required, to keep harness secure and from being seen. 8 tie straps are provided in the harness package.

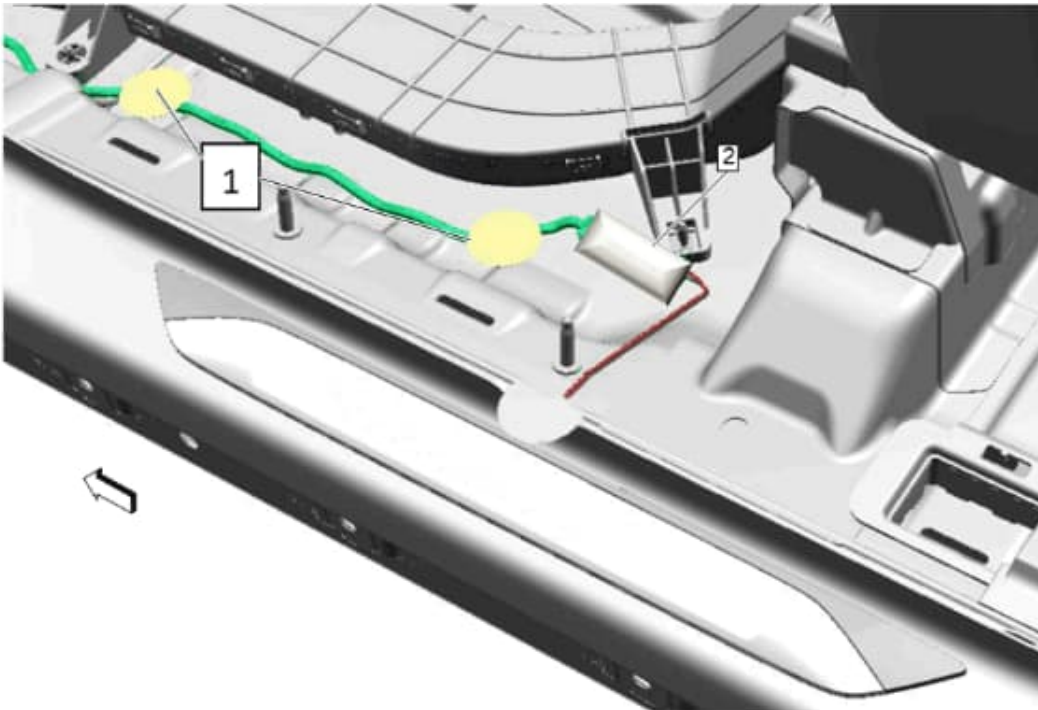

**Note:** Two foam tapes are provided in the harness package.

2. Use foam tape (2), as required, to keep wire harness connector from making noise.

**Note:** Eight abrasive tapes are provided in the harness package.

3. Use abrasive tape (1), as required, to keep connector secure and from being seen.
4. Pull back the carpet and route the harness along the floor about 50 to 75 mm below the top of the carpet, from side to side. Use retainer to reinstall the carpet on the driver side.

#### **Re-install Carpet and Trim**

1. Check clips on removed trim panels, replace clips if necessary.
2. Tuck wire harness behind carpet and trim.
3. Reposition carpet, and reinstall removed trim panels and weather strips.

**Note:** Verify all wires are neatly secured, pinched and not visible, tie straps should be used as necessary to keep harness secured and out of sight.